

Article number: 2031120M30150B2U

Description: E+G levelling foot
GN 31-120-M30-150-B2-U

Note: U Without nut, Hexagon socket at the top, Wrench flat at the bottom

Measures

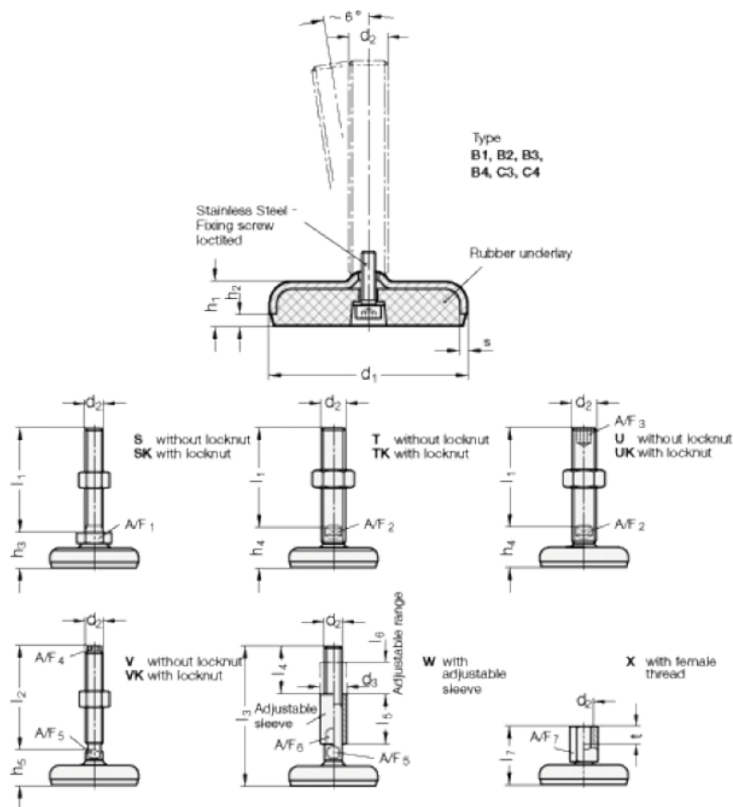

A/F2	= 24	s = 4
A/F3	= 12	
d1	= 120	
d2	= 30	
h1	= 22	
h2	= 6	
h4 +4.0/0	= 46	
l1	= 150	